

MOSS GRAPHIC DOOR HANDLE USER MANUAL

Installation & Combination Setting – Model YL-99



MOSS

MOSSINC.COM | 800.341.1557

Table Of Contents

Section 1. Safety Warnings and Guidelines	3	Section 6. Passage Code Information & Instructions	6
1.1 Disposal at End of Life	3	6.1 General Passage Code Information	6
Section 2. Features & General Information.....	4	6.2 Setting The Passage Code	9
2.1 Features	4	6.3 Deleting The Passage Code	9
2.2 General Information	4	6.4 Entering Passage Mode	10
Section 3. Battery Information	5	6.5 Exiting Passage Mode	10
Section 4. Master Code Information & Instructions	5	Section 7. Resetting.....	10
4.1 General Master Code Information.....	5	7.1 Soft Reset.....	10
4.2 Changing The Master Code.....	6	7.2 Hard Reset.....	11
Section 5. User Code Information & Instructions	6	Section 8. Disguising Your Code	11
5.1 General User Code Information.....	6	Section 9. Lock Components.....	12
5.2 Setting The User Codes	7	Section 10. Install Instructions	13
5.3 Changing The User Codes	7	Section 11. FAQ	14
5.4 Deleting The User Codes.....	8		

Section 1. Safety Warnings and Guidelines

It is important that you follow all instructions and regard all notes that appear throughout this manual . Consult this manual before you attempt to use your TURBOLOCK YL-99 Digital Door Lock. If you have questions not answered by this manual, contact TURBOLOCK customer service.

1.1 Disposal at End of Life

This product must not be disposed of by incineration, landfilling, or mixing with household trash. Improper disposal of the battery contained within this product may result in the battery heating up, rupturing, or igniting which may cause serious injury. The substances contained inside the battery present chemical risks to the environment. The recommended disposal for any YL-99 at its end-of-life is to dispose of the entire unit at or through an e-Waste recycling center, program, or facility. Local regulations and laws pertaining to the recycling and disposal of lithium ion batteries and/or products containing them will vary according to country, state, and local governments. You must check laws and regulations corresponding to where you live in order to properly dispose of the battery and/or unit. It is the user's responsibility to dispose of their waste equipment properly with accordance with local regulations and laws.

For additional information about where you should drop off your batteries and electrical or electronic waste, please contact your local or regional waste-management office, your household waste disposal service, or your point-of-sale.

Section 2. Features & General Information

2.1 Features

- Backlit keypad for use in low light environments
- Up to 10 code combinations, including: passage, user and master codes
- Passage Mode for hassle-free entry
- User-friendly instructions for DIY use
- An LED indicator lights up to show when codes and commands have been successfully entered
- Built-in disguise feature to protect your codes from prying eyes
- Low battery warning indication

2.2 General Information

The YL-99 electronic lock is capable of storing up to 10 codes: 1 master code, 1 passage code, and 8 user codes. All codes are allocated a starting number or sequence number. The starting numbers are as follows, '0' for the master code, '1-8' for the user codes, and '9' for the passage code. The master code must be set up in order to input additional codes.

This user manual will guide you through the functions and installation of your YL-99. If you have any questions or cannot find the information you need in the manual, please contact your place of purchase or our customer service immediately. Before contacting customer service, please have your model number and purchase information ready as any of these may be needed during the call.

Section 3. Battery Information

The lock requires four 'AAA' alkaline batteries which are housed in the internal handle. The lock has a low battery indicator which, when unlocking the door, will sound a continuous beep followed by a single beep.

New batteries should be installed as soon as possible after receiving any low battery indication. When the notification begins, the lock will only have enough power for approximately 50 times before the batteries are fully depleted. Expected battery life is approximately 365 days with an estimate of 3000 uses per 365 days.

If the batteries are completely dead, you can use the included emergency backup battery pack to power the lock. However, it is recommended not to continue use of the backup longer than necessary; ensure that the batteries in the lock are replaced immediately. Please keep the emergency backup battery pack in an accessible area at all times. In the event of a power failure, the battery pack will be needed to unlock the lock. See page 15 for the step by step usage instructions.

Note: *It is highly recommended to insert the batteries only after the lock is fully installed.*

Section 4. Master Code Information & Instructions

4.1 General Master Code Information

The following information applies to your YL-99's master code:

- The master code is the most important code in the series as it is needed to set up all other codes.
- All codes can be a maximum of 15 digits including the sequence number.
- The sequence number for the master code is '0', therefore you must ensure this is the first digit of your code. The remainder may be any combination of digits from '0-9'.
- The default master code is '0123'.

- To unlock the lock with the master code for the first time, enter the code '0123' and press the '#' key. The lock will emit sound and the green indicator will light up. While sound emits, the lock is unlocked and will return to the locked position immediately after the sound stops.
- Remember, the door should always be ajar when adding and/or changing codes.

4.2 Changing The Master Code

1. Enter the default ('0123') or the current master code, and press the '#' key.
2. Wait until the beeping sound stops but the blue backlight remains on.
3. Enter a new master code starting with '0' and press the '*' key. The lock will emit two beeps to confirm the code has been successfully saved.

Note: *If the master code is lost or forgotten, it may be deleted via a hard reset of the lock. Refer to Section 7.*

Section 5. User Code Information & Instructions

5.1 General User Code Information

The following Information applies to your YL-99's user codes:

- All codes can be a maximum of 15 digits including the sequence number.
- The sequence numbers for the user codes are '1-8', therefore you must ensure the first digit of each user code is any number from '1-8'. The remainder may be any combination of digits from '0-9'
- To unlock the lock with a user code, enter the code beginning with a number '1-8' and press the '#' key. The lock will emit sound and the green indicator will light up. While sound emits, the lock is unlocked and will return to the locked position immediately after the sound stops.
- Remember, the door should always be ajar when adding and/or changing codes.

5.2 Setting The User Codes

Follow the instructions below to set a user code:

1. Enter the current master code and press the '#' key.
2. Wait until the beeping sound stops and the blue backlight remains on.
3. Enter a new user code starting with its sequence number and press the '*' key i.e. the first user code should start with '1', the second should start with '2', and so on. The lock will emit two beeps to confirm the code has been successfully saved.
4. If desired, repeat the steps above until all eight user codes '1-8' have been successfully set

Note: *Each user code must be entered while the blue backlight is on. If the light goes out, you must re-enter the master code to unlock the lock again before proceeding.*

5.3 Changing The User Codes

Follow the instructions below to set a user code. When changing a user code, the master code or the existing user code must be entered first. This means users will have the ability to change their own codes.

1. Enter the master code or user code you want to change and press the '#' key.
2. Wait until the beeping sound stops and the blue backlight remains on.
3. Enter the new user code and press the '*' key. The lock will emit two beeps to confirm the code has been successfully saved.

Note: *The new user code must have the same sequence number as the prior code i.e. if the previous user code started with '1', the new user code must still begin with '1'.*

5.4 Deleting The User Codes

To delete an *individual* user code, follow the instructions below.

1. Enter the master code and press the '#' key.
2. Wait until the beeping sound stops and the blue backlight remains on.
3. Enter '0000' and the sequence number of the code you want to delete and press the '*' key e.g. to delete the user code starting with one, enter '00001'. The lock will emit several beeps to confirm the selected user code has been erased.
4. If desired, repeat the steps above to delete any other user codes.

Note: *If multiple user codes are lost or forgotten or otherwise should be erased, they may be deleted via a soft or hard reset of the lock. Refer to Section 7.*

Section 6. Passage Code Information & Instructions

After the passage code is set, the YL-99 may be set to passage mode by entering the passage code. In passage mode, all users can press any key to open the door without requiring a code.

6.1 General Passage Code Information

The following information applies to your YL-99's passage code:

- All codes can be a maximum of 15 digits including the sequence number.
- The sequence numbers for the user codes are '1-8', therefore you must ensure the first digit of each user code is any number from '1-8'. The remainder may be any combination of digits from '0-9'.

- To unlock the lock, enter the code beginning with a number `1-8` and press the `#` key. The lock will emit sound and the green indicator will light up. While sound emits, the lock is unlocked and will return to the locked position immediately after the sound stops.
- The passage code doubles as an additional user code. It may be entered to open the lock.
- Remember, the door should always be ajar when modifying any code in any way.

6.2 Setting The Passage Code

Follow the instructions below to set the passage code.

1. Enter the current passage code and press the `#` key.
2. Wait until the beeping sound stops and the blue backlight remains on.
3. Enter a new passage code starting with `9` and press the `*` key. The lock will emit two beeps to confirm the code has been successfully saved.

Note: *The passage code will always begin with `9`.*

6.3 Deleting The Passage Code

Follow the instructions below to delete the passage code.

1. Enter the master code and press the `#` key.
2. Wait until the beeping sound stops and the blue backlight remains on.
3. Enter `00009` and then press the `*` key. The lock will emit several beeps to confirm the code has been erased.

6.4 Entering Passage Mode

In this mode, any digit '0-9' may be used to open the lock.

1. Enter the Passage Code then press '#'.
2. After the beep stops and before the blue backlight goes off, press '*' then '#' in quick succession. The lock will emit several beeps to confirm Passage Mode is active.

6.5 Exiting Passage Mode

Follow the steps below to exit passage mode.

1. Press any key to activate the lock.
2. After the beep stops and before the blue backlight goes off, press '*' then '#' in quick succession. Once you hear two beeps passage mode is canceled.

Section 7. Resetting

If needed, all codes including the user and passage codes may be deleted. To reset the master code, continue reading to the end of this section.

7.1 Soft Reset

To delete *all* user codes follow the instructions below:

1. Enter the master code and press the '#' key.
2. Wait until the beeping sound stops and the blue backlight remains on.
3. Enter '00000' and press the '*' key. The lock will emit several beeps to confirm all user codes have been erased.

Note: *Once all user codes are erased, only the master code will be able to operate the lock.*

7.2 Hard Reset

If needed, a hard reset may be performed on the lock to erase all codes including the master code. After a hard reset, the master code will return to its default '0123' and all other codes will have been erased. A hard reset should only be used when the master code is lost or forgotten.

To delete *all* user codes, including the master code, follow the instructions below:

1. Use a screwdriver to remove the screws from the inside knob cover.
2. Remove the cover and find the reset button located on the battery pack.
3. Press and hold the reset button for five seconds until three beeps are heard. The master code will return to the manufacturer default code '0123'.

Section 8. Disguising Your Code

This function is an added security feature which is aimed at preventing codes being observed while being entered.

1. Enter the first digit of the code you want to enter.
2. Randomly enter any number of digits to confuse the observer.
3. Enter the remainder of the code, followed by the '#' key

Example:

Your code is '333'.

Enter the first digit: '3'.

Randomly enter any digits to confuse the observer.

Enter the remainder of the code: '33' and press '#'.

Section 9. Lock Components

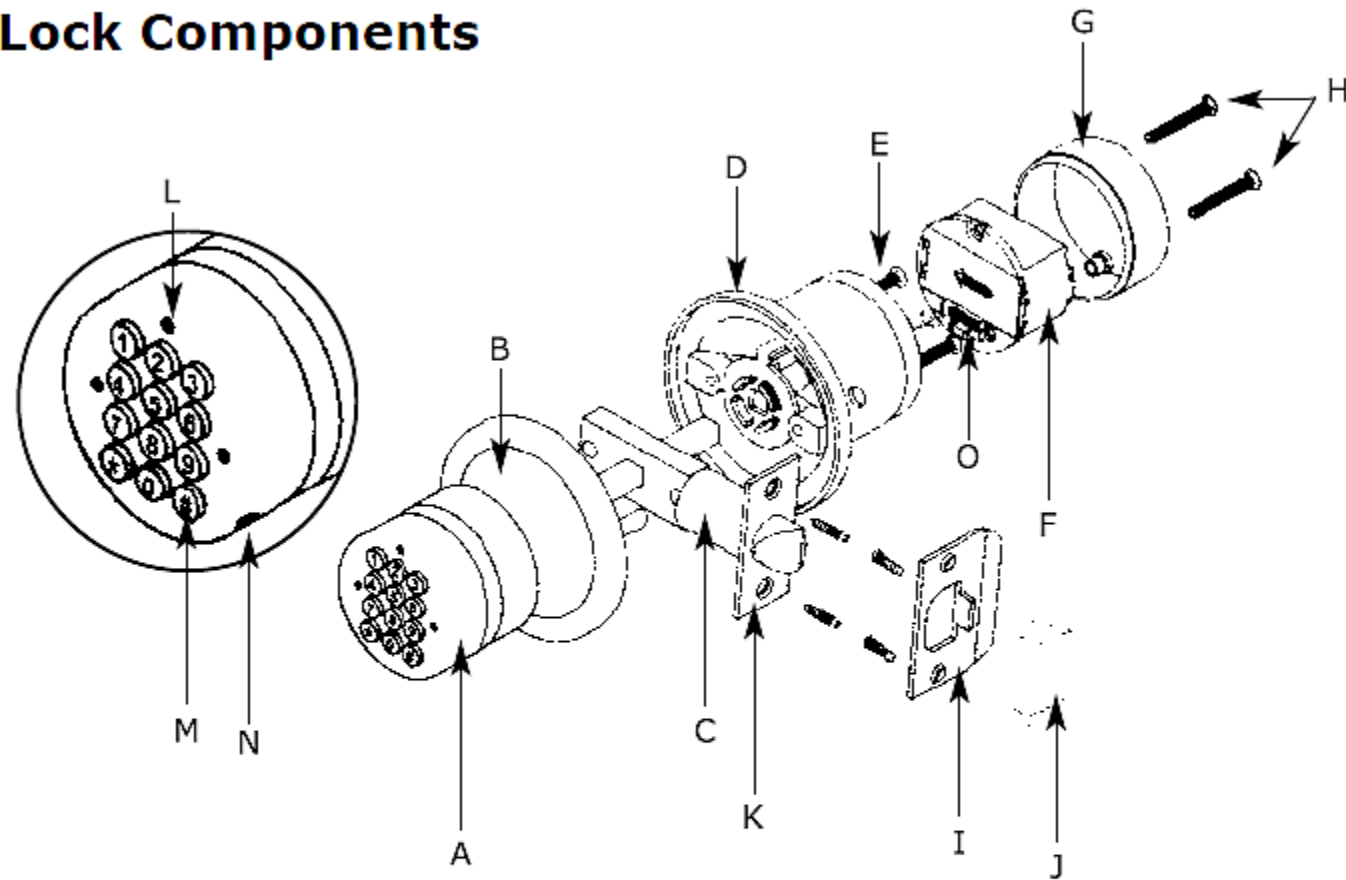

A: Outside Knob
 B: Outside Rose Plate
 C: Latch Assembly
 D: Inside Rose Plate
 E: Mounting Screws

F: Battery Box
 G: Inside Knob Cover
 H: Cover Plate Screws
 I: Strike Plate
 J: Wrought Box

K: Latch Faceplate
 L: LED Indicator
 M: Keypad
 N: Emergency Power Jack
 O: Reset Key

Section 10. Install Instructions

Step 1. Install Latch
Slide latch into the edge of the door. Use (2) screws to attach.

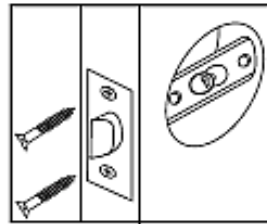

Step 2. Install Outside Knob
Feed the power cable through latch and guide spindle through until outside rose sits flush.

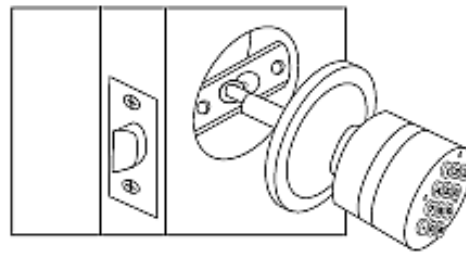

Step 3. Install Inside Knob

- Feed power cable through hole in knob and guide spindle into handle. (Fig 3a)

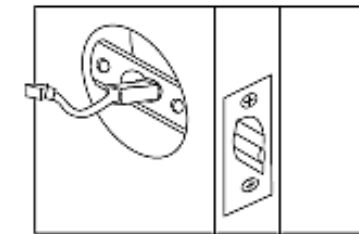

(Fig 3a)

- Screw inside knob to outside knob using mounting screws. (Fig. 3b)

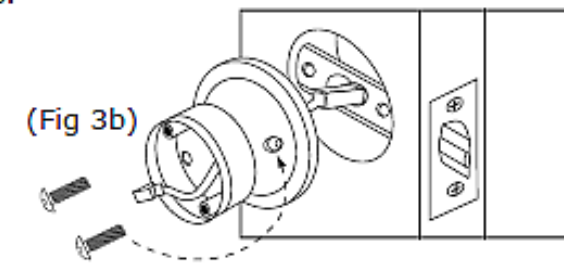

(Fig 3b)

Step 4. Plug in Battery Box

Insert power cable into battery box and position box in line with cover screw holes.

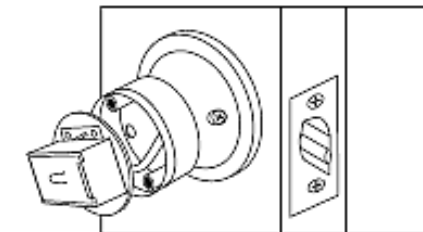

Step 5. Install Inside Cover Plate

- Position cover plate over battery box and align with screw holes.

- Fasten screws to secure cover plate to inside knob.

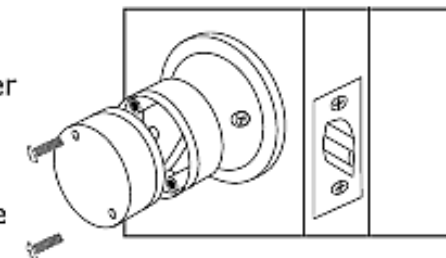

Section 11. FAQ

Why is it beeping?

The battery may be low. Please replace the battery.

The lock doesn't work.

Try replacing the battery or using the backup battery. If the lock still does not work, contact customer support.

Why can't I open the door?

You may be waiting too long to open the door. After entering a code, turn the handle to open the door while the lock is still emitting sound. Once it stops emitting sound, the lock will return to locked position immediately.

I forgot all my codes.

The lock must undergo a hard reset in order to set the master code back to default and erase all other codes. In order to perform a hard reset, you must have access to the back of the door. (Refer to Section 7)

How do I open the door if the batteries are dead?

If the batteries are completely dead, you can use the included emergency backup battery pack to power the lock. However, it is recommended not to continue use of the backup longer than necessary; ensure that the batteries in the lock are replaced immediately. Please keep the emergency backup battery pack in an accessible area at all times. In the event of a power failure, the battery pack will be needed to unlock the lock. See page 5 Section 3, for more details.

Step 1. Using the Back Up Battery Pack
Install (4) AAA batteries into the pack.



Step 3. Plug Battery Pack
Plug the battery pack into the plug location at the bottom of the key pad.



Step 2. Plug in Location
Locate the plug in location, at the bottom of the key pad. Remove the plastic insert.



Step 4. Use Code
Use the key code to open.

